

JIS	MAS 403 BT
DIN	69882-8

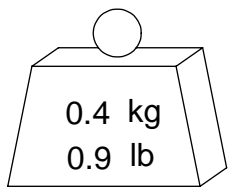
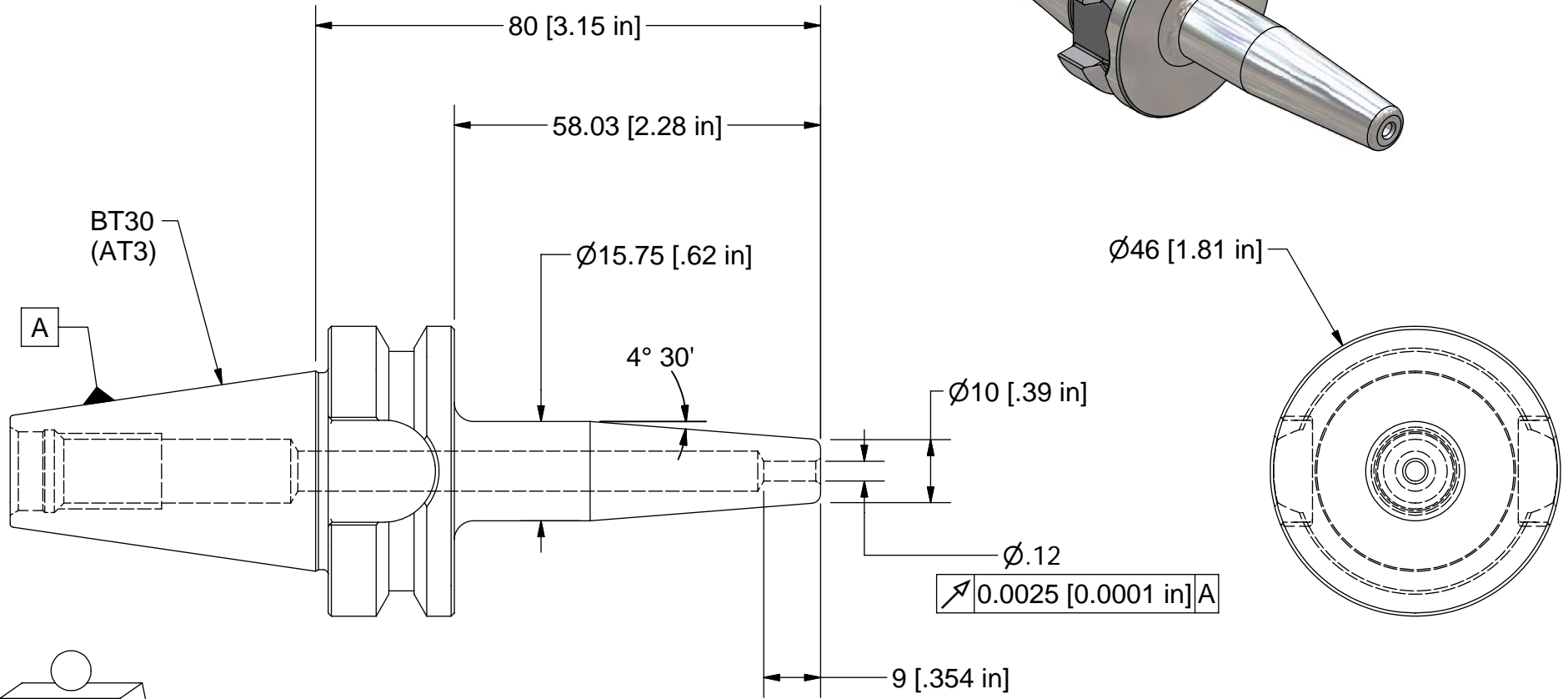
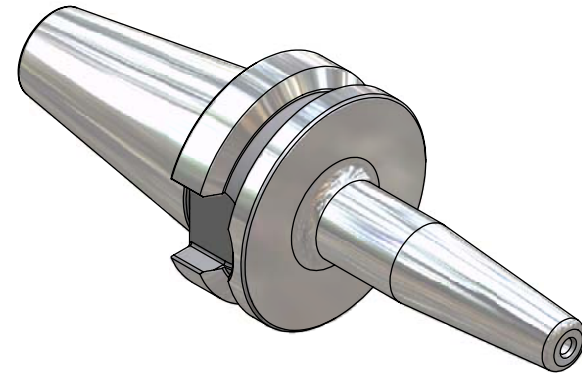

BALANCE
G2.5 @ 25,000 RPM

PART NUMBER
BT30-01SF315-9

PARLEC
(800) TOOL USA
WORLD HEADQUARTERS
101 PERINTON PARKWAY
FAIRPORT, NEW YORK 14450