

Parts List

ITEM	QTY	PART NUMBER	DESCRIPTION
1	4	029-965	SET SCREW, M4 x 6 W/360 DEG. PATCH
2	1	BS-SFM161-20	ADJUSTING SCREW OPTIONAL

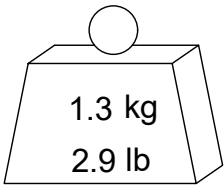
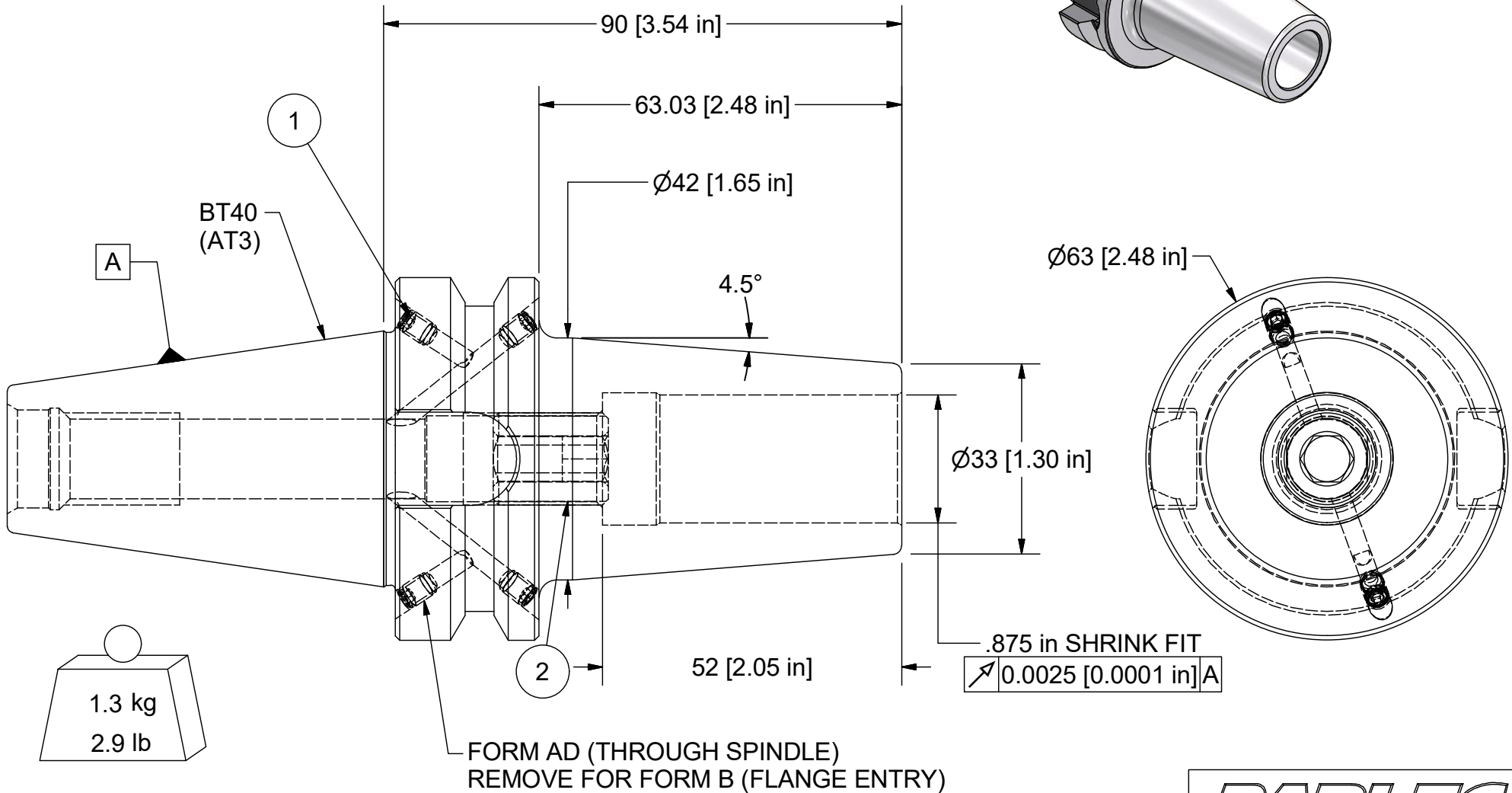
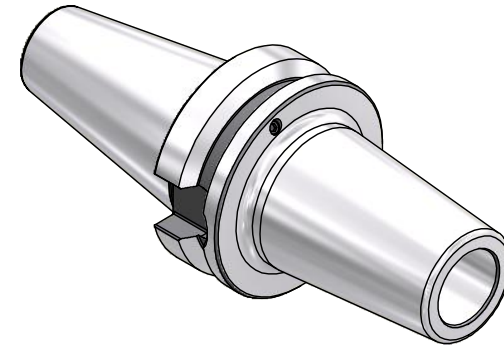

BALANCE
G2.5 @ 20,000 RPM

PART
NUMBER

BT40-88SF354-9

PARLEC
 (800) TOOL USA
 WORLD HEADQUARTERS
 101 PERINTON PARKWAY
 FAIRPORT, NEW YORK 14450