

Parts List

ITEM	QTY	PART NUMBER	DESCRIPTION
1	2	029-965	SET SCREW, M4 x 6 W/360 DEG. PATCH
2	1	BS-SFM161-20	ADJUSTING SCREW OPTIONAL

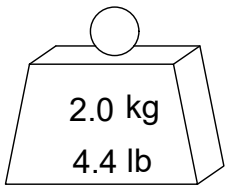
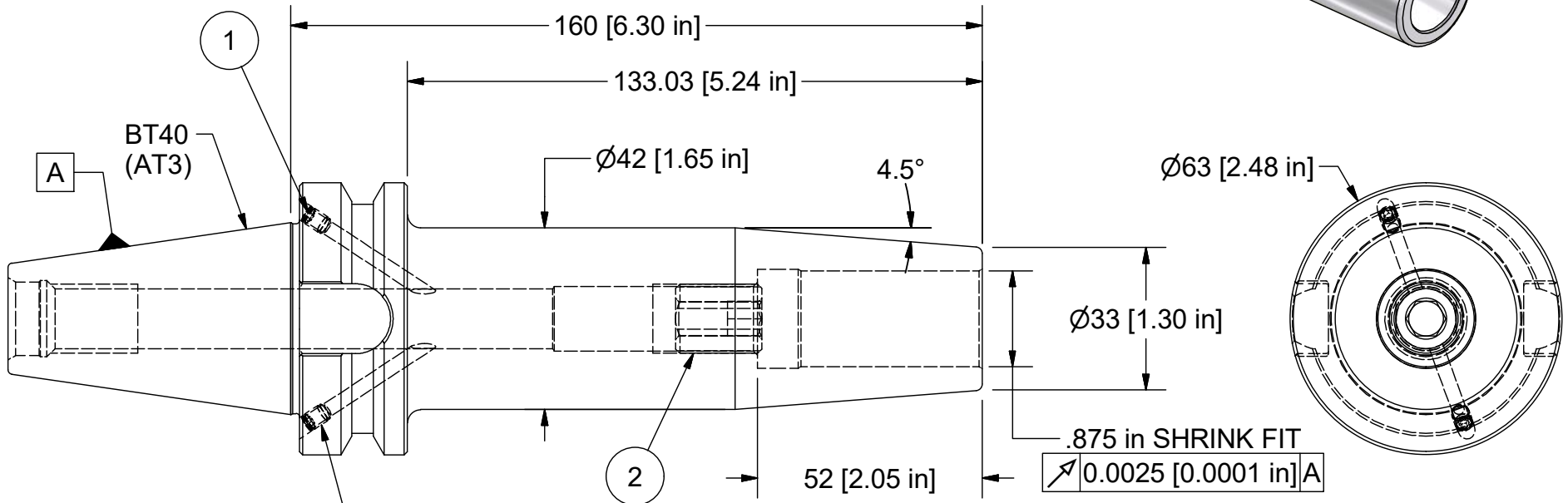
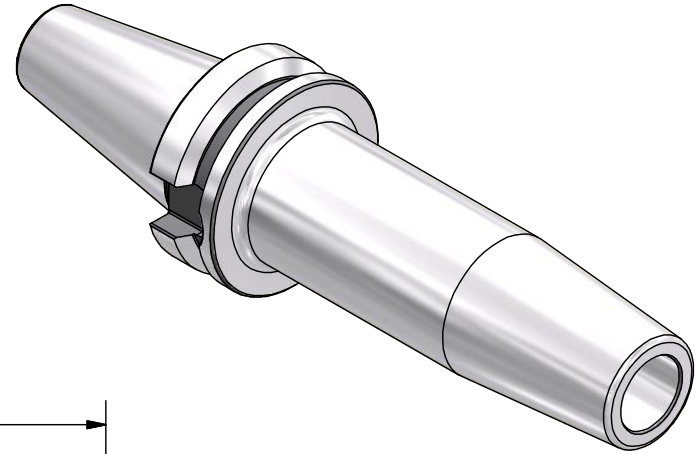

FORM AD (THROUGH SPINDLE)
REMOVE FOR FORM B (FLANGE ENTRY)

BALANCE
G2.5 @ 20,000 RPM

PART
NUMBER

BT40-88SF630-9

PARLEC
(800) TOOL USA
WORLD HEADQUARTERS
101 PERINTON PARKWAY
FAIRPORT, NEW YORK 14450